

No reproduction in any form of this manual, in whole or in part (except for brief quotation in critical articles or reviews), may be made without written authorization from Forcemech International LLC.



# FORCEMECH



FORCEMECH SERIAL NUMBER & CERTIFICATE OF AUTHENTICATION

 **ULTRALITE G10**

# FORCEMECH

FULL CARBON FIBER FRAME

 **ULTRALITE G10**

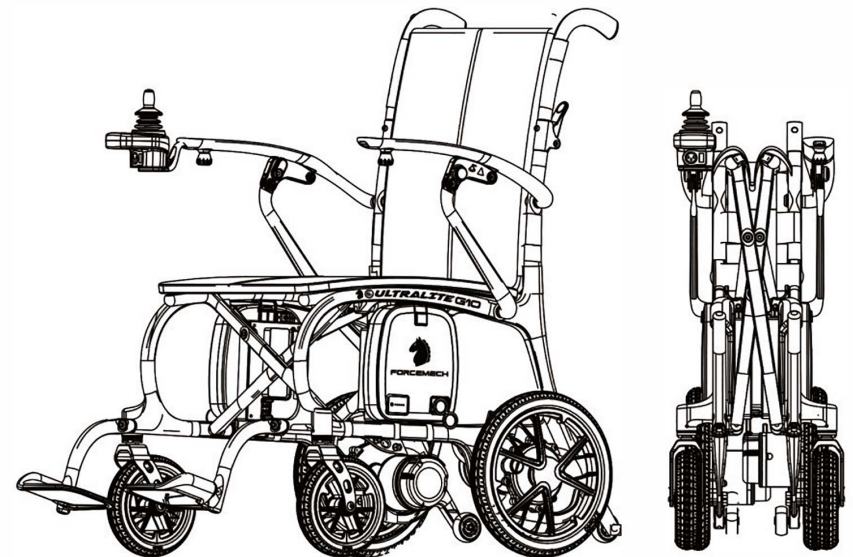

## User Instructions Manual

Forcemech International LLC.

4219 CLAY COMMERCE DR. 103 KATY TX, 77449

PHONE: 877-903-6723 EMAIL: support@forcemech.com

©2024 Forcemech International LLC.

WWW.FORCEMECH.COM

SUPPORT@FORCEMECH.COM

**CONTENTS**

CONTENTS ..... 1

1.INTRODUCTION ..... 2

2.PRECAUTIONS FOR SAFE USE ..... 3

3.PERFORMANCE AND STRUCTURE ..... 14

4.TECHNICAL SPECIFICATIONS..... 15

5.ASSEMBLING FOLDING AND ADJUSTING ..... 17

6.USE AND OPERATION ..... 20

7.FAULT ANALYSIS AND TROUBLESHOOTING ..... 25

8.SAFETY PROTECTION DEVICE AND ACCIDENT HANDLING..... 26

9.MAINTENANCE AND REPAIR ..... 26

10.TRANSPORTATION AND STORAGE ..... 29

11.GENERAL GUIDANCE ..... 29

12.PACKAGE CONTENT ..... 30

13.WARRANTY AND CONTACT ..... 30



**1.INTRODUCTION**

Thank you for purchasing our Forcemech Ultralite G10 powerchair. we take pride in manufacturing the highest quality of products. This powerchair is a completely new design by Forcemech, borrowing ideas from the Ultralite G10's carbon fiber frame and of a classic folding wheelchair, with a total weight of just 25lbs without cushion and battery installed. We combined our expertise in design and manufacturing with our customer's feedback through the years, adding many features and upgrades to our previous iterations of this signature model with major upgrades including battery performance, riding comfort, and ease of use. This chair defines Forcemech's quality and superiority amongst the industry.

We hope this power chair will provide you comfort and mobility throughout your daily activities and remain steadfast by your side for the adventures ahead!

Please Read and follow all instructions, warnings, and notes in this manual before attempting to operate your powerchair for the first time. If there is any information in this manual which you do not understand, or if you require additional assistance for assembly or operation, please contact your authorized local dealer. To use your product safely depends on whether you strictly follow the warnings, attentions and operating instructions in this manual. The company shall not be responsible for any injury or damage caused by non-compliance with the warnings, attentions and operating instructions.

The symbols below in this manual are used to identify warnings and important information. All of them are very important to your safety. It is strongly recommended that you should read and understand them completely.

	<b>Warning!</b> Failure to heed the warnings in the manual may result in personal injury.
	<b>Attention!</b> Failure to heed the attentions in the manual may result in damage to the wheelchair.

1.1 This product integrates advanced technology and modern style. In particular, its quick disassembly and assembly structure is very convenient for you to store or place in the trunk of your car when you travel. We are sure that the design features, excellent performance and trouble-free operation of this product will ensure your daily life is more convenient.

1.2 This power wheelchair is applicable to the disabled. The maximum loading weight is 300lbs.

1.3 Intended use:

This device is used for the disabled or elderly people with weight of no more than 300lbs, and limited to one -person use.

1.4 Operator:

The device can be operated by the user self or caregiver.

1.5 Patient populations:

Disabled or elderly people with weight of no more than 300lbs.

1.6 Environment in which the wheelchair is intended:

Ambient temperature range: -20°C~50°C.

Relative humidity range: 15%~90%.

Atmospheric pressure range: 70kPa~106kPa.

**2.PRECAUTIONS FOR SAFE USE**

**2.1 Expiration Date**

This power wheelchair is energy and reusable product.

The safe and period of validity for wheelchair on the clinical use not only depends on its structural strength, but also on the user usage and use of the product environment, user habits, whether in accordance with the periodic maintenance, and other factors.

Our products are valid from the date of production for 5 years.

**2.2 Instructions before use**

2.2.1 If not completely read and understand the user manual, please do not drive.

2.2.2 The maximum loading capacity is shown in the parameter table for technical features. Please do not overload while driving. And it is single use, please do not carry passengers.

2.2.3 Please do not drive after drunk or too tired.

2.2.4 Please do not drive at night or in case of an unclear line of sight.

2.2.5 The visually impaired cannot drive alone, which may cause personal injury.

2.2.6 Please self-check before driving and refer to the manual section "adjusting" and "Practice before operation " if driving for the first time.

2.2.7 This wheelchair is not waterproof, do not expose in rain and snow as well as driving in rain or snow.

2.2.8 The wheelchair is waterproof to a certain extent, and the waterproof rating is IPX4.

**2.3 Attention in use**

2.3.1 This power wheelchair can drive on a good flat surface; do not drive on muddy, rugged, soft, narrow, icy roads, bad roads such as dangerous roads without guardrails or waterways.

2.3.2 This power wheelchair has the certain ability of groove the obstacle, at this time you should reduce the speed and travel slowly.

2.3.3 This power wheelchair has the certain climbing ability, the climbing angle is  $\geq 3^\circ$ , but no more than  $10^\circ$ .

2.3.4 Please avoid driving in the crowds, traffic flows and other places with heavy traffic.

2.3.5 Please ensure that the control system is firmly installed, the joystick is vertical, correctly positioned. Please sit well and buckle up in time, keep your head as back as possible, lean against the backrest in case out of control due to tip-over.

2.3.6 Press the on/off button, firstly check if the current fastest speed setting is appropriate for your operating proficiency, or it should be adjusted for safety; We recommend to drive slowly at the beginning for each use, and gradually accelerate.

2.3.7 Indications for use: This power wheelchair is a motor driven, with the intended use to provide mobility to a disabled or elderly person limited to a seated position. This product is suitable for disabled people with mobility difficulties and elderly people.

**2.4 Electromagnetic interference (EMI)**

Electromagnetic interference is from external electromagnetic wave energy (like radios, TV transmission stations, CB radio waves, and garage door starters, radio phones, etc.). Electromagnetic interference may affect the control system of the power wheelchair. Some interference may lead to brake failure, power on automatically, or steering failure, also may lead to the permanent damages to the control systems.

Below cables information are provided for EMC reference.

Cable	Max . cable length , Shielded/unshielded		Number	Cable classification
AC Power Line	1m	shielded	1Set	AC Power
DC Power Line	0.95m	shielded	1Set	DC Power

**Important information regarding Electro Magnetic Compatibility (EMC)**

This electrical medical equipment needs special precautions regarding EMC and put into service according to the EMC information provided in the user manual; The equipment conforms to this IEC 60601- 1-2:2014 standard for both immunity and emissions. Nevertheless, special precautions need to be observed: The equipment with ESSENTIAL PERFORMANCE/Following ESSENTIAL PERFORMANCE is intended used in home healthcare environment. ESSENTIAL PERFORMANCE:

The power wheelchair can work normally without moving out of control, and the speed change is not more than  $\pm 20\%$ .

**WARNING:** Use of this equipment adjacent to or stacked with other equipment should be avoided because it could result in improper operation. If such use is Necessarily, this equipment and the other equipment should be observed to verify that they are operating normally.

The use of accessories, transducers and cables other than those specified or provided by the manufacturer of this equipment could result in increased electromagnetic emissions or decreased electromagnetic immunity of this equipment and result in improper operation.

**WARNING:** Portable RF communications equipment (including peripherals such as antenna cables and external antennas) should be used no closer than 30 cm (12 inches) to any part of the ULTRALITE G10, including cables specified by the manufacturer. Otherwise, degradation of the performance of this equipment could result ."

**WARNING:** If the use location is near (e.g. less than 1.5km from) AM, FM or TV broadcast antennas, before using this equipment, it should be observed to verify that it is operating normally to assure that the equipment remains safe with regard to electromagnetic disturbances throughout the expected service life.

When the AC input voltage is interrupted, the equipment will stop battery charging and if the power supply restored, it could be recovered automatically, this degradation could be accepted because it will not lead to unacceptable risks and it will not result in the loss of basic safety or essential performance.

EMI Compliance Table (Table 1)

Table 1 - Emission

Phenomenon	Compliance	Electromagnetic environment
RF emissions	CISPR 11 Group 1 , Class B	Home healthcare environment
Harmonic distortion	IEC 61000-3-2 Class A	Home healthcare environment
Voltage fluctuations and flicker	IEC 61000-3-3Compliance	Home healthcare environment

EMS Compliance Table (Table 2-5)

Table 2 - Enclosure Port

Phenomenon	Basic EMC standard	Immunity test levels
		Home healthcare environment
Electrostatic Discharge	IEC 61000-4-2	±8kV contact ±2kV, ±4kV, ±8kV, ±15kV air
Radiated RF EM field	IEC 61000-4-3	20V/m 26MHz-2.5GHz 80% AM at 1kHz 10V/m 80MHz-2.7GHz 80% AM at 1kHz
Proximity fields from RF wireless communications equipment	IEC 61000-4-3	Refer to table 3
Rated power frequency magnetic fields	IEC 61000-4-8	30A/m 50Hz or 60Hz

Table 3 – Proximity fields from RF wireless communications equipment

Test frequency (MHz)	Band (MHz)	Immunity test levels
		Home healthcare environment
385	380-390	Pulse modulation 18Hz , 27V/m
450	430-470	FM , ±5kHz deviation , 1kHz sine , 28V/m
710	704-787	Pulse modulation 217Hz , 9V/m
745		
780		
810		
870	800-960	Pulse modulation 18Hz , 28V/m
930		
1720		
1845	1700- 1990	Pulse modulation 217Hz , 28V/m
1970		
2450		
5240	2400-2570	Pulse modulation 217Hz , 28V/m
5500		
5785		
	5100-5800	Pulse modulation 217Hz , 9V/m

Table 4 – Input a.c. power Port

Phenomenon	Basic EMC standard	Immunity test levels
		Home healthcare environment
Electrical fast transients/burst	IEC 61000-4-4	± 2kV 100kHz repetition frequency
Surges Line-to- line	IEC 61000-4-5	± 0.5kV, ±1kV
Conducted disturbances induced by RF fields	IEC 61000-4-6	3V, 0.15MHz-80MHz 6V in ISM bands and amateur radio bands between 0.15MHz and 80MHz 80%AM at 1kHz
Voltage dips	IEC 61000-4-11	0% UT; 0.5cycle At 0°, 45°, 90°, 135°, 180°, 225°, 270°and 315°
Voltage interruptions	IEC 61000-4-11	0% UT; 250/300 cycles UT=rated input voltage

Table 5 – Signal input/output parts Port

Phenomenon	Basic EMC standard	Immunity test levels
		Home healthcare environment
Electrostatic Discharge	IEC 61000-4-2	± 8kV contact ±2kV, ±4kV, ±8kV, ±15kV air

**WARNING!** Please observe the WARNINGS below to avoid any damage or injury resulted from improper use of your wheelchair. The wheelchair user is responsible for taking proper safety measures. We will not be liable for personal injury and/or product damage resulted from improper use of the wheelchair. Obey all local pedestrian traffic rules. It may be difficult for others to see you when you are seated on your wheelchair. Wait until your path is clear of traffic, and then proceed with extreme ATTENTION. Use of safety devices such as reflectors, reflective clothing, lights and safety symbols is very important for your safety while driving.

 **WARNING!** NEVER try a new manoeuvre on your own, out of the manual stated .

 **WARNING!** Do not use the wheelchair other than for its original purpose. Avoid any use, such as weight training sports and athletics, hauling , moving or towing anything, that may lead to safety hazards and undue stress on the wheelchair.

 **WARNING!** We strongly recommend that you do not smoke cigarettes while seated on your wheelchair. You must adhere to the following safety guidelines if you decide to do so: Keep ashtrays a safe distance from the seat cushions. Always make sure cigarettes are completely extinguished before disposal.

 **WARNING!** When driving a wheelchair, stay away from fuel, such as oxygen, alcohol, otherwise it will increase the risk.

 **WARNING!** The parts of this wheelchair are flame retardant parts, and the parts should not be replaced at will, otherwise the combustible risk will increase.

 **WARNING!** Before getting on/off the wheelchair, you should sit behind as far as possible to avoid injury caused by overturning. **WARNING!** Avoid holding on armrest, which will cause rollovers and injuries. **WARNING!** Avoid concentrating your weight on the footrest. Otherwise, it will cause overturning and personal injury.

 **WARNING!** Do not use the wheelchair in manual mode without accompanying person , which may cause personal injury. **WARNING!** When sitting in the wheelchair, please do not move by yourself, which may cause personal injury. Ask your accompanying person for help if necessary.

 **WARNING!** Do not make any alterations to the wheelchair without permission . Adding accessories may change some of the wheelchair specifications such as total weight , size , or center of gravity. Please note that some changes may damage things around you.

 **WARNING!** Please do not change your seat specification Do not place any cushions or pillows on the seat , which will result in the user falling out from the wheelchair caused by instability of seat.

 **WARNING!** Be extremely careful when using oxygen near electrical circuits or combustible materials. Please contact your oxygen supplier for information on the safe use of oxygen.

 **Attention!** Do not change the controller Settings. Please ask your service provider to check it if you notice any changes in your ability to control the wheelchair.

 **WARNING!** During the operation , the wheelchair may suddenly stop at any time Do not operate wheelchair if it is abnormal or irregular.

 **WARNING!** To prevent the wheelchair from losing control and moving on its own , do not place the wheelchair in manual mode on any inclined plane.

 **WARNING!** If you expect to sit in a fixed position for a long time , turn off the power to prevent movement of the wheelchair.



**WARNING!** Avoid any accessories that may interfere with the operation of the joystick . Otherwise , it will cause the wheelchair to move unexpectedly.



**WARNING!** Keep yourself, clothing and other objects away from the wheel while the wheelchair is moving. Do not drag anything behind the wheelchair while driving.



**Attention!** Do not connect any other devices to the electronic system or turn on any other devices with the wheelchair battery.



**Attention!** When disconnecting wiring harness , please hold the terminal in case damage to it . Do not pull the wiring harness directly.



**WARNING!** Keep all charger connector terminals clean and dry, away from damp sources to prevent damage to electrical system and personal injury.



**Attention!** The storage temperature of wheelchair is -25℃~70℃ . Long term storage in low or high temperature environment will damage its function.



**Attention!** Always check electrical components for Corrosion. Check all brakes for looseness, wear or damage. Check wiring harnesses and terminal posts for breakage. If necessary, please do the replacement.



**Attention!** Please ensure the safety of wheelchairs and batteries during transportation. Never transport wheelchairs or batteries with combustible materials.



**Attention!** Do not connect the cable directly to the battery terminal/clip for charging.



**Attention!** Do not remove the fuse from the battery harness . If the fuse is damaged , please contact your supplier for replacement.



**WARNING!** Do not operate the wheelchair with dead battery. You might get trapped. **WARNING!** Please slow down when turning, don't make sharp turns, keep the center of gravity stable when turning. To prevent rollover, do not move the center of gravity in the opposite direction when turning. **WARNING!** Drive straight up the slope when climbing . Both front wheels should land at the same time . To reduce the possibility of overturning, do not make an angle with the slope; do not make the wheel on one side or the side of the wheelchair to go up the slope first. Be particularly careful when climbing any slopes.



**WARNING!** Do not drive on potentially dangerous roads or slopes, including but not limited to roads covered with snow, ice , cut grass, or wet leaves .



**WARNING!** Please drive down a slope at the minimum speed. If the descent speed is faster than expected, release the joystick lever to stop the wheelchair, and then press the lever lightly to control the descent speed.



**WARNING!** Do not place the wheelchair in the front seat of vehicle during transportation. Otherwise, it may move and disturb the driver.



**Attention!** Please contact your service provider if any accessories of seat unit become loose; Please replace the worn or damaged parts immediately.



**WARNING!** The recommended maximum climbing angle (see parameter table) was tested in a controlled environment. The climbing ability of your wheelchair is affected by factors such as your weight, the speed of your wheelchair, and the angle at which you approach the slope.



**WARNING!** Reversing is only possible on roads. When reversing, please operate smoothly at low speed. Please stop frequently and check to make sure there are no obstacles on the road. To prevent rollover, do not tilt down or backward along the slope.



**WARNING!** When sitting in a wheelchair, avoid any position or movement that can change your center of gravity. This may cause the wheelchair to tilt. **WARNING!** Do not put all the weight on one side of the wheelchair armrest, such use may cause the wheelchair to tilt.



**WARNING!** Do not put your hands above the seat or tilt your body. This may damage the backrest and cause you to fall down.



**WARNING!** Even if your wheelchair can cross high obstacles, we recommend that you do not try to cross the specified height. Such operations may cause the wheelchair to be unstable, even rollover and cause severe personal injury. If you have any concerns about safely crossing obstacles, please ask for help. Please pay attention to your operating skills and personal restrictions. You may need to remove or cover the sills and install ramps at exits and entrances.



**WARNING!** Do not attempt to climb over obstacles on.  
**WARNING!** Do not rely on a wheel to get over obstacles.



**WARNING!** Never operate the wheelchair near railroad tracks or crossings.



**WARNING!** Do not drive the wheelchair along the edge of a stream, lake or sea. Please do not drive the wheelchair across the water.



**WARNING!** Do not expose wheelchair to open flames.





**ATTENTION!** Keep your wheelchair in a dry and clean environment. Don't take the wheelchair to shower, bath, pool or sauna. Rain, snow, salt, fog / spray conditions and frozen / smooth surfaces can cause wheelchair screws and some fixtures to rust untimely.





**ATTENTION!** Avoid prolonged exposure to excessively hot and cold environments; it may damage the cushioned and non-cushioned parts of the wheelchair as well as the battery and battery components.

 **ATTENTION!** Do not drag the wheelchair. Dragging may exceed its own speed threshold ,causing damage to key parts of the wheelchair.

 **ATTENTION!** Be extremely careful when moving an idle wheelchair up and down the stairs .The wheelchair must be folded , requiring the participation of physically capable people.

 **WARNING!** Do not cross stairs or escalators with the wheelchair.

 **WARNING!** Do not sit on a wheelchair while it is in any transport vehicles.

 **WARNING!** For safer handling: Always keep the power off before moving . Failure to do so may result in touching the joystick and causing the wheelchair to move unexpectedly. Make sure the brakes are locked so to prevent the wheelchair from moving during handling . This wheelchair could be driven into the elevator, while you must turn off the power and sit firmly to ensure that the wheelchair will not move after entering the elevator.

 **WARNING!** Please consult your healthcare professionals routinely to ensure there are no health or physical conditions that may limit or impair your ability to safely operate your wheelchair. Consult your physician if you are taking prescription or over-the-counter medication or if you have any physical limitations. Some medications and physical limitations may impair your ability to safely operate your wheelchair.

 **WARNING!** Do not operate your wheelchair while you are under the influence of alcohol , as this can impair your ability to safely operate your wheelchair.**WARNING!** Every wheelchair is different. Take the timeto learn it before your driving.**WARNING!** BE AWARE that becoming a capable and safe wheelchair operator will take time and practice.

 **WARNING!** To ensure your safety, please read and understand this manual . You must be on high alertness when driving any wheelchair to ensure safety.

 **WARNING!** Radio wave sources , such as radio stations , television stations , amateur radio transmissions ,two-way radios and mobile phones can affect wheelchair control .The following WARNINGS should reduce the possibility of severe injury due to accidental braking or movement of the power wheelchair:

1. Do not turn on portable personal communication devices , such as citizen band (CB) radios and mobile phones when the power wheelchair is powered on;
2. Pay attention to nearby transmitters , such as radio or television stations , and try to avoid approaching them .
3. In the event of unexpected movement or brake release , the power wheelchair should be turned off as soon as possible under safe conditions;
4. Please note that adding accessories or parts,or modifying power wheelchairs may make it more susceptible to interference from radio wave sources (note: there is no easy way to assess the influences of above modifications on the wheelchair's overall immunity from radio wave sources ); and report to the power wheelchair manufacturer of all accidents of unexpected movement or brake release , and pay attention to nearby radio sources and other important information.

 **Attention!** Please return the discarded batteries,controllers, motors,etc. to the supplier or manufacturer for disposal to avoid environmental pollution.

 **WARNING!** That surface temperatures can increase when exposed to external sources of heat. May cause your burns.



**3.PERFORMANCE AND STRUCTURE**

**3.1 Product Structure**

The Power wheelchair is mainly composed of front wheel, drive wheel, frame, controller, motor and drive devices, armrest, push-handle, backrest, seat cushion, footrest, battery box and charger. The structural diagram is as below.

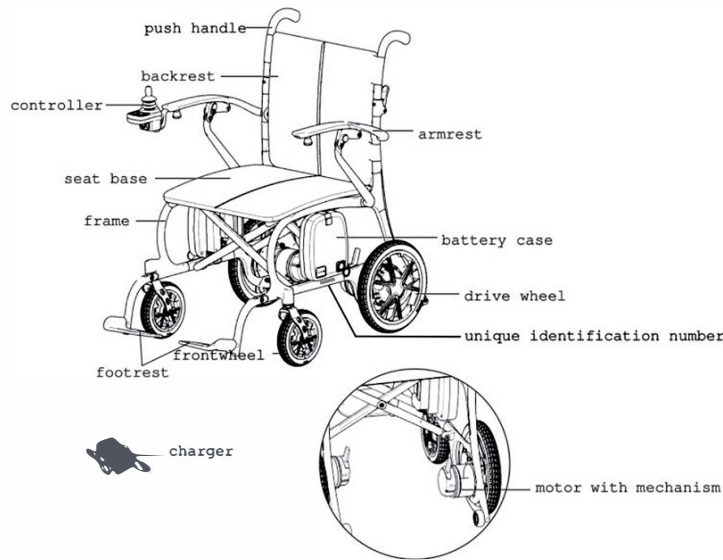

**3.2 Electric diagram of power wheelchair**

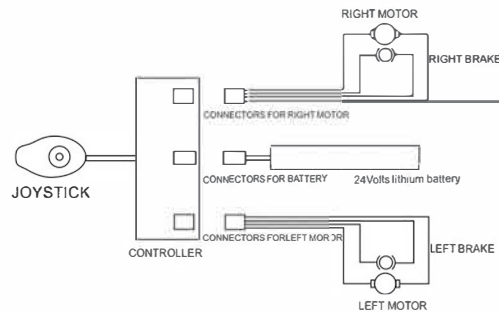

**4.TECHNICAL SPECIFICATIONS**

Technical Specifications of the Forcemech Ultralite G10

Overall dimensions(L*W*H)	36"x24"x35"
Folded dimensions(L*W*H)	29"x12"x28"
Total weight (with battery)	27lbs
Battery weight	2lbs
Mass of the heaviest part	2.8lbs
Pivot width	44"
Reversing width	59"
Tturning radius	28"
Ground clearance	1.25"
Required width of angled corridor	39"
Required doorway entry depth	62"
Required corridor width for side opening	35"
Static stability	9°
Driving distance	10mi
Dynamic stability uphill	6°
Climbing ability	3°
Maximum Climbing Degree	10°
Max over the obstacle height	±1"
Maximum speed forward	≤4mph
Minimum braking distance from max speed	≤39"
Seat plane angle	4°
Effective seat depth	16.5"
Seat width	18"
Effective seat width	20"
Seat surface height at front edge	17.3"
Backrest angle	8°

Backrest height	17.5"
Back support height/Backrest height	16.4"
Distance from Footrest to Seat	15.3"
Distance from Footrest to Surface	3"
Footrest length	4.5"
Footrest to leg angle	97°
Leg to seat surface angle	114°
Armrest height	9.5"
Front location of armrest structure	14"
Armrest Length	15"
Armrest Width	2"
Armrest Angle	2.5°
Audible noise	≤65 dB(A-weighted)
The forces necessary to operate the control devices	Push-button 2N Rockers ≤5N
Motor Model	ZW9012L3A-S 24V/150W*2
Lithium Battery Specification	24V10Ah
Maximum Output Current of Controlle	35A
Maximum Output Current of Charger	2A
Diameter of movable wheels/Castor wheel diameter	6.5"
Diameter of fixed wheels/Propelling wheel diameter	11"
Tolerance	
Linear Tolerance	±2"
Angular Tolerance	±2°
Mass Tolerance	±4.4lbs

Note:

- 1) The weight capacity is tested with a dummy or personnel of same weight.
- 2) Maximum potential range is tested on flat road with average speed, it will vary due to drive surface, operation habit, etc.



**Attention!** The Driving distance will be reduced if the wheelchair is used frequently on slopes, rough ground or to climb kerbs, etc.

### 5. Assembling , Folding and Adjusting

#### 5.1 Assembling

5.1.1 Take out the wheelchair from the packing box and put it on the ground. Push the chair-frame apart to left and right, and press two tubes on both sides of the seat base down into the grooves on both sides of the chair-frame. (Fig.1)

5.1.2 Uprear the backrest (Fig.2), and the spring pin should be clicked into the hole on the backrest tube. (Fig.3) Then tie the backrest cloth cover to the frame and stick the Velcro, And the drop the footrests. (Fig.4)

5.1.4 Put the controller on the armrest. And then pull down the tightening spanner on the controller to fasten the controller. (Fig.5)

5.1.5 Before power on the wheelchair, the battery must be fixed on the frame as that put it into the upon rail and then press down to the bottom till it has a “click” sound. (Fig.6)



Fig.1



Fig.2



Fig.3



Fig.4



Fig.5



Fig.6

**5.2 Folding**

Please operate according to below methods if transport or store the power wheelchair:

1. Put the wheelchair on flat ground and turn off the power supply.
2. Turn the footrest upward. (Fig.7)
3. The frame can be folded by pulling up the seat lever from both sides as well as pulling up the two handle straps under the seat cushion.(Fig.8)



**5.3 Adjusting**

5.3.1 Each motor has one brake lever. When the lever is pushed at location A, the wheelchair will be in electric mode, which will only be operated by power. When the lever at location B, the wheelchair will be in manual mode, which will only be pushed by hand. (Fig.9)

- 5.3.2 Press the power switch on joystick, and battery indicator light is on.
- 5.3.3 Rotate the joystick lever toward front to the end, observe the rotation of wheelchair wheels, then rotate other direction to observe if there is rotation for the wheels.
- 5.3.4 Release the joystick lever, it will be come back to middle position, then you observe the wheels should be stopped.

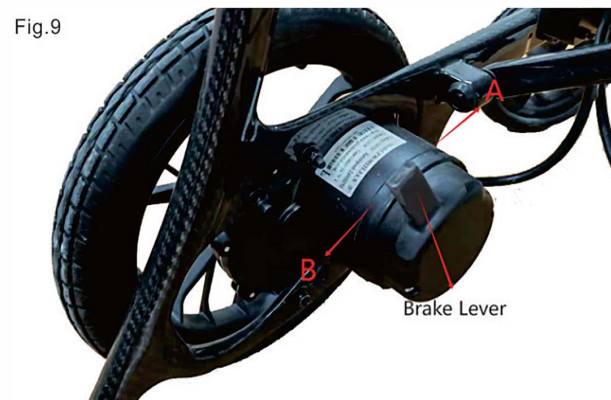

5.3.5 The armrest can be flip up, better for being on/off the chair. (Fig.10)



5.3.6 The positions of points where the component parts can be gripped for safe moving and handling and/or a method for handling during dismantling, assembly or carrying(Fig11);



**6. USE AND OPERATION**

6.1 Use

6.1.1 All the electric components to control the wheelchair are integrated to the joystick, including ON/OFF switch; speed light; battery gauge; speed light; speed down button; speed up button; joystick. You can implement all the operations of this wheelchair by using the above buttons. (Fig.12)



Fig.12

6.1.2 ON/OFF switch: It is the switch to supply power to the control system. Press the ON/OFF switch to turn the power on. The power indicator speed light and battery gauge will be on. Press it again, the power is off, then speed light as well as the battery gauge will turn off.

6.1.3 Speed down button: After turning on the power, the speed light displays the current maximum driving speed, and will decrease by one bar with each press on it. The number of displayed bars shows the current maximum speed. The range could be adjusted by the user.

6.1.4 Speed up button: After turning on the power, speed light displays the current minimum driving speed, and will increase by one bar with each press on it. The number of displayed bars shows the current maximum speed. The range could be adjusted by the user.

6.1.5 Battery gauge: It displays the battery storage. All bars lit up: power is sufficient; 3-4 bars displayed indicates the power is OK. Lower than 2 bars indicate lack of power and the battery needs to be charged. Note: Wheelchairs are often used on slopes, rough ground or climbing up the roadside will make the power indicator displays drop quickly.

6.1.6 Joystick: The joystick is mainly used to control the wheelchair's movement including its speed and direction (forward, backward and left or right etc). The further you push the joystick from its central position, the faster the wheelchair moves. Whenever you release the joystick, it will automatically go back to the center and the brake will be automatically operative to stop the wheelchair.

6.1.7 Reserving sound can be closed by pressing the buttons of speed-down and horn simultaneously for 3 seconds. If need to turn it on, please press the buttons of speed-up and horn for 3 seconds at the same time, and then the sound will be on.

6.1.8 Charger Socket: It is only used to this wheelchair. Do not use the socket to supply power to any other electrical equipment. Otherwise, it may damage the wheelchair's control system or its EMC performance (Electromagnetic tolerance).

**!** **WARNING!** Avoid any accessories that may intervene the operation of joystick. Otherwise, the wheelchair may move accidentally.

**!** **WARNING!** If your wheelchair moves accidentally, please immediately release the joystick and the chair will stop automatically.

**X** **CAUTION!** If you connect any devices other than the supplied battery charger into the socket, causing damage to the control system, then the warranty is invalid.

6.2 Batteries and Its Usage

6.2.1 Fully charge your new battery prior to its initial use. This brings the battery up to about 90% of its peak performance level; Give the battery another full charge of 4-6 hours and operate your wheelchair again, the batteries will now perform at over 90% of their potential; After four or five charging cycles, the batteries will reach 100% charge and last for an extended period. Please replace a new battery when the battery failure, and the old battery must be returned to supplier because of environmental pollution. The battery is guaranteed for 1 year.

**X** **CAUTION!** Do not use your wheelchair when the temperature is less than -25°C or above 50°C.

6.2.2 Charging batteries

The battery charger is an important part of the wheelchair. Off-board charger attached to this product can charge its batteries quickly, easily to make your wheelchair the best. The battery charger must be in accordance with below specification:

Charger	Model:QL-09005-B2402000F/60HZ 24V2A
the rated input voltage range	AC100-240V
the rated d.c. output current	2000mA
the rated d.c. output voltage	24V
the operating temperature range	0-35°C
the types of the batteries that can be charged	Lithium Battery

Assignment of charging connector pins.(Fig.13)

6.2.3 Battery Removal

Press and hold the button with your hand, and at the same time pull the battery box up to remove it.(Fig.14)

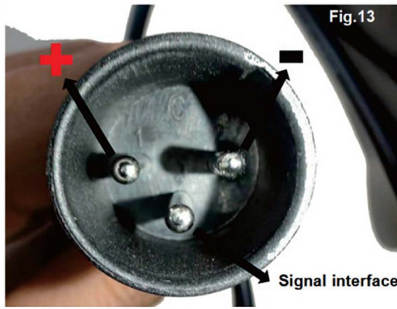

Fig.13



Fig.14

**!** **WARNING!** The battery pack must be properly installed into the slide rail, otherwise the wheelchair will become unusable.

6.2.4 Charge the battery with charger. Method 1: Connect charger to charging port on controller. Method 2: remove the battery from wheelchair and directly charge it. (Fig.15)

Fig.15



**!** **WARNING!** Please charge the battery at environment temperature 0-35°C, Stay away from combustible items, combustible gases

6.2.5 Safety Belt

For your safety on the way, you have to fasten the safety belt whenever you sit on the wheelchair.

Snap the belt buckle to hear a “click” sound (Fig.16)



Fig.16

**!** **WARNING!** Please do not operate the wheelchair while charging.

**X** **ATTENTION!** The battery carried by the wheelchair met the IEC62133 standard. Please replace with battery of same type, chemical substances and capacity. Please select the battery type and capacity per specification in the manual. Please use the replacement battery directly provided by the authorized supplier(s) to ensure the performance and function.

**X** **ATTENTION!** Please protect the battery from freezing; Please do not charge the frozen battery, otherwise the battery may be damaged.

6.3 Battery replacement

If the battery needs to be replaced, release the battery pack buckle underneath the seat then take it out. The battery must be in accordance with below specification:

Type	Lithium Battery
Dimension	190*160*50mm
Voltage	24V

6.4 Operation

6.4.1 Preparation before operation

●Do not turn on the power switch before sitting on the wheelchair, and do turn off the power switch before getting off of the wheelchair. Please observe whether the brake works or not.

●Please fold out the footrest first then hold the armrest to sit on the wheelchair; Do not get off the wheelchair by stepping on the footrest. Otherwise, the wheel chair maybe turned over, which is dangerous.

6.4.2 Practice before operation

●Find a spacious place like square and have an assistant to help you practice until you have enough confidence to operate it.

●Be certain to shut down the power when you get on and off the wheelchair, and set a speed you need through speed adjustment button.

●We recommend you set the lowest speed until you can operate the electric wheelchair skillfully.

●Practice stopping, moving forward and backward. Push the joystick lever, the wheelchair moves to anywhere you want.

●Firstly, ensure that it is the lowest speed when practice forward operation. After skilled, you can practice "S" shaped turn. After you are familiar with "S" shaped turn, to practice backward operation, and pay attention to the speed control setting. And the backward speed should lower than forward speed.

(As shown below)

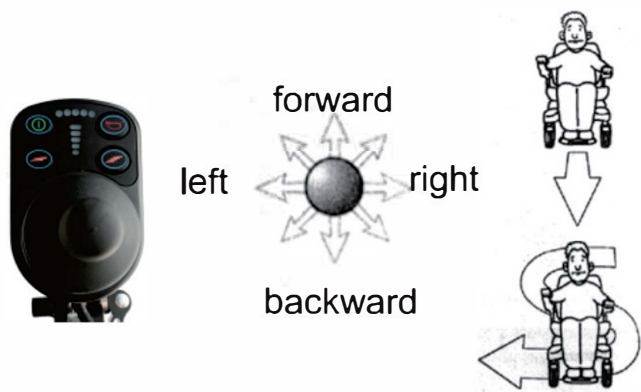

**WARNING!** Do not press the joystick hard by hand when getting on/off the wheelchair to avoid any accident(Fig.17)

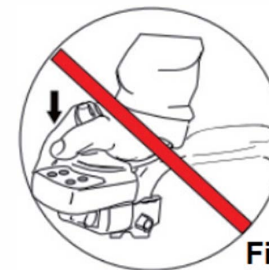

**Fig.17**



**WARNING!** Do not use your wheelchair unless getting help form your assistant when the wheelchair is in manual mode. Otherwise it may result in personal injury.

Do not set your wheelchair in manual mode by yourself while you are seated in the wheelchair. Otherwise it may result in personal injury. In this case, please ask your assistant to help you.

Do not set your wheelchair in manual mode when it is on an incline. Otherwise, the wheelchair could be out of control to roll down by itself, and result in personal injury.

**7. FAULT ANALYSIS AND TROUBLE SHOOTING**

For your convenience, this wheelchair is equipped with an automatic fault warning system. If the wheelchair is not working as it should, you can find the fault according to the table below. If the fault persists after checking, please contact your service agent.

Beep 2+1	Communication failure	Check connection inside the joystick
Beep 2+2	Right motor failure	Check right motor or wire connection
Beep 2+3	Right brake error or cable connection poor	Check if th brake lever is in place & if the brake is damaged
Beep 2+4	Left motor failure	Check left motor or wire con nection
Beep 2+5	Right brake error or cable connection poor	Check if the brak lever is in place & if the brake is damaged
Beep 2+6	Overcurrent	Check if the motor is locked or short circuit of if the joystick is damaged
Beep 2+7	Joystick lever failure	Check if the joystick lecer works normally or the inside connection is loose
Beep 2+8	Joystick failure	Check with supplier for repair
Beep 2+9	Battery failure	Charge the battery, if still ont work, replace a new battery with same specification

**ATTENTION!**  
 In order to ensure the quality of wheelchair, during the maintenance, if any consumable parts such as battery, wheels, joystick, motor/actuator and charger need to be replaced, please contact this company or dealer, replacing the original parts of same model and specification.

**8. SAFETY PROTECTION DEVICE AND ACCIDENT HANDLING**

- 8.1 Overload protector: Refer to instruction manual 6.1.7
- 8.2 Safety belt: Refer to instruction manual 6.1.9
- 8.3 Please release the joystick whenever there is a wheelchair fault, the wheelchair will be stopped.

**9. MAINTENANCE AND REPAIR**

**9.1 Maintenance**

Like other motorized wheelchair, your power wheelchair also requires routine maintenance. Some checks can be performed by yourself, others you can ask for assistance from your service agent. Preventive maintenance is very important. If you follow the maintenance and checks in this section, your wheelchair will give you years of trouble-free operation. For any questions regarding the maintenance or operation of the wheelchair, please contact your dealer or our after-sales service dept.

**9.1.1 Humidity**

Your wheelchair, like most electrical and mechanical equipment, is susceptible to external conditions. In any case, the wheelchair should be avoided damp environment. Direct or prolonged exposure to water or dampness could cause the wheelchair to malfunction electronically and mechanically. Water can cause electrical components to corrode.

**9.1.2 Temperature**

- Some parts of your wheelchair are susceptible to temperature.
- In extremely cold temperature, the battery may be frozen. Special temperatures may cause a lot of factors to freeze, like charger type, usage, battery components;
- Temperature above 55° may cause your wheelchair's speed to reduce.

**9.1.3 Regular guidance**

- Avoid hitting the controller, especially the joystick.
- Avoid prolonged exposure of your wheelchair to extreme conditions, such as hot, cold or moisture environment.
- Keep the controller clean.
- Check all electric connections, including the cable and connectors of the charger, and ensure that they are all tight and secure.

- If only red LED on the Battery Gauge lights, the batteries are nearly running out of charge. You should recharge the batteries as soon as possible. We recommend charging the battery for 8-12 hours.
- The frame surface has been sprayed with a clear sealant coating. You can apply a light coat of car wax to make the surface keep a high gloss.
- Check all cable connections. Make ensure they are well connected and not corroded. The battery must be placed in the battery area with good connection.
- All wheel bearings are lubricated and sealed. Do not need to lubricate them.
- Check if there is loose phenomenon for wheel hub, drive device, and chair itself, if loose, please screw tightly in time.

**9.1.4 Maintenance after use**

- Turn off the power.
- Inhibit children and unconscious persons to use the wheelchair.
- Store the wheelchair in normal temperature to prevent deformation so that it keeps its performance for long period.
- Clean the wheelchair with a clear and soft cloth and dry it. Never use any chemicals to clean it. (to prevent deformation and discoloration).
- Remove the cloth cover of the seat rest to be washed if it is dirty, and then dry it for use.

**9.1.5 Daily Checks**

In order to keep the wheelchair always in good condition, you should check it before each use and keep weekly, monthly, semi-annual check. See the table below for the inspection items.

Inspection Items	At any time	Weekly	Monthly	Semi-annual
Each part			☉	
Turning, driving, setting, dismantlement, etc		☉		
brake	☉			
Connecting lines		☉		
Battery condition	☉			
Tire Condition			☉	
Motor				☉
Devices		☉		
Cleanliness	☉			

9.1.6 Cleaning

Way of cleaning as below:

- Never wash your wheelchair with water or expose directly to water.
- Surface of wheelchair frame is coated with a protective coating. Therefore, it is very easy to wipe it clean with a damp cloth. Never use any chemicals to clean the wheelchair, as they may cause the latter slip or chapped. You can use a damp cloth and neutral soapy water to clean them, and then dry thoroughly.

9.2 Repair

9.2.1 Users could repair or replace some spare parts like push handle, push handle cover which could be self- maintained or replaced under the instructions of after-sales service staff of the dealers.

9.2.2 Within the warranty, the dealers will maintain or replace the faulted spare parts, like motor, battery, charger, controller, bearing, shaft sleeve, etc., due to material or manufacturing defects free of charge.

9.2.3 The spare parts like motor, controller, etc. , what are confirmed by the after-sale staff or our corporation or our dealers to be disassembled could be sent to our corporation or the dealers for maintenance.

9.2.4 Please contact your distributor or the after-sale service dept of our corporation for any questions regarding the maintenance of power wheelchairs.

**ATTENTION!**



In order to ensure the quality of wheelchair, during the maintenance , if any consumable parts such as battery, wheels , joystick ,motor/actuator and charger need to be replaced , please contact this company or dealer, replacing the original parts of same model and specification.The repair should be carried out at the professional maintenance room of our corporation or the dealer(s) .

**10. TRANSPORTATION AND STORAGE**

10.1 Transportation

You can load and transport the wheelchair according to the shipping marks and graphics on cartons. For details, see the attachment.

10.2 Storage

Your wheelchair should be stored in a clean indoor environment with relative humidity ≤90%, temperature between -25~70°, good ventilation and free from corrosive gas. Remove the battery from the wheelchair prior to storage. Otherwise, the frame may rust and the electronics may be damaged.

**11. GENERAL GUIDANCE**

11.1 Avoid knocking or hitting the control units;

11.2 Avoid prolonged exposure of your wheelchair to extreme conditions, such as hot, cold or moist environment; keep the controller clean.

11.3 Check all connections, and ensure that they are all tight and secure.

11.4 Check all cable connections, including the cable connection of the charger. Make sure they are firmly fastened and not corroded. The battery pack must be correctly installed into the slide rail.

11.5 After each use, the power switch should be turned off in time to reduce unnecessary consumption of the battery.

11.6 The wheelchair has power-saving function. If there is no operation to the wheelchair within 20 minutes, the controller would cut off the power automatically. If need to continue operating this wheelchair, please turn it on again.

11.7 All wheel bearings are lubricated and sealed. No need to lubricate them.

**12. PACKAGE CONTENTS**

Open the packing box, and you can check whether there is anything missed or damaged. Packing List

No.	Name	Quantity	Remark
1	Power Wheelchair	1pc	FORCEMECH ULTRALITE G10
2	Charger	1pc	Model:QI-09005-B240200F160HZ 24V2A
3	Lithium Battery	1pc	24V10Ah
4	Instruction Manul	1pc	
5	Controller	1pc	

**13. WARRANTY AND CONTACT**

13.1 Forcemech International LLC. offers a limited warranty to your Carbon series and its parts against defects in materials and/or workmanship, contact us immediately if you notice there is an ongoing issue with your power chair.

1. Main frame – five years
2. Motors – one year
3. Controller Box(CPU) – one year
4. Batteries – one year
5. Joystick Controller – one year

13.2 There are exclusions to our limited warranty:

1. Damage to the power chair caused by exceeding the weight limit of 300lbs.
2. Damage to the power chair caused by accidents or natural disasters.
3. Damage to the power chair due to improper use and handling.
4. Modifying power chair with unauthorized installation of components not from Forcemech.
5. Charging the powerchair with a 3rd party charger that resulted in damage to the chair and/or the battery.
6. Consumables such as cushions, tires and bearings are not covered.
7. This warranty does not apply to routine maintenance and adjustments.
8. This warranty only applies to the original buyer and is not transferable.



### Contact Forcemech

For questions on how to operate the chair, warranty claims, purchasing parts or any other issues you may have related to the power chair, please contact us. We will be happy to assist you.

by phone: 1-877-90-FORCE

by email: [support@forcemech.com](mailto:support@forcemech.com)

When contacting Forcemech, please have one of the following ready and we will be able to locate your order quickly to better assist you. For warranty claims, it is required, together with your purchase receipt, in order for us to verify your purchase.

A. Serial Number (located on the back cover of this manual as well as on the chair under the seat frame).

B. Order Number (whichever retailer/online platform you purchased our chair from).

